

# INCEPTOR® IONA

## Technical Specification

Product Code: OV65208CTASD

Description: 20W 230mm Diameter Switch Dimmable Downlight With CTA Switch - IP44 - White

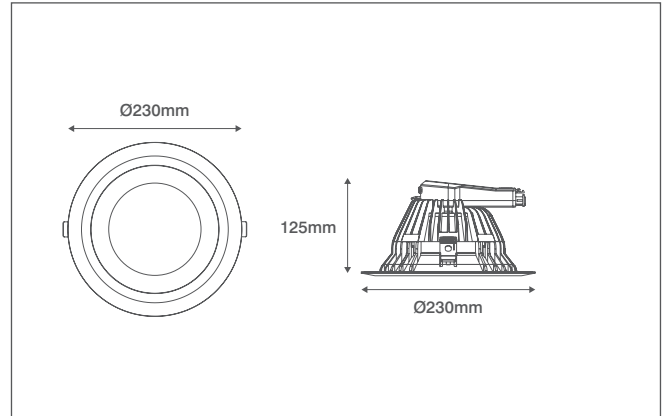

### General Information

Dimensions	230mm Diameter x 125mm (D)
Materials	Bezel & Heatsink: Powdercoated Aluminium Diffuser: Polycarbonate Engine Housing: Polycarbonate
Finish	White (RAL 9003)
Product Weight	0.928Kg
Cutout	190mm Diameter
Dimmable	Yes (Switch Dim)
Ingress Protection	IP44
Warranty	5 Years

### Supply & Power

Input Voltage & Frequency	220-240V~ 50/60Hz
Electrical Safety	Class II (Double Insulated)
LED Wattage	20W
Circuit Wattage	20W
Input Current	110mA
In-rush Current	4.22A (91.2µs)
Power Factor	>0.9
Ambient Temperature (Ta)	-15°C - +25°C
Critical Temperature	+80°C
LED Driver	Integrated
Prewired Flow™ Connector	Yes (3 Pole CT105-F Push-fit Terminals)
Dimming Input Termination	2 Pole Flow™ Connector (CT001-F)

### Luminaire Output

Colour Temperature	2700K	4000K	6500K
Typical Luminous Flux	1500lm	1650lm	1600lm
Efficacy	75lm/W	83lm/W	80lm/W
Beam Angle	75°		
CRI	>80		
LED Lifetime (L70)	50,000 Hours		

### Accessories

OVCGEM6500	3 Hour Emergency Pack With prewired Flow™ Connectors
------------	--

### Additional Information

4.6V DC Switch Dim voltage supplied by the fitting

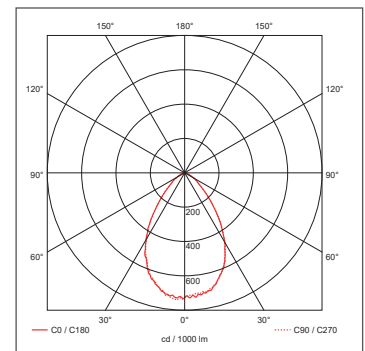

2700K

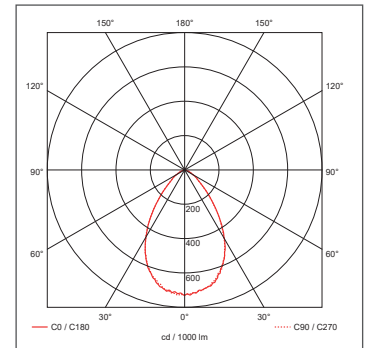

4000K

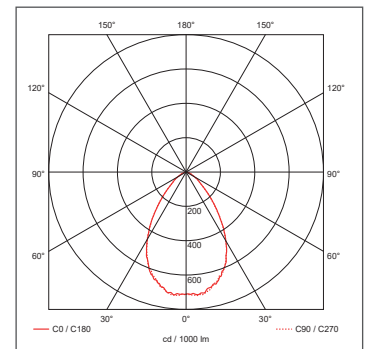

6500K



Ovia Limited, Scolmore House, Mariner, Lichfield Road Industrial Estate, Tamworth, Staffordshire, B79 7UL United Kingdom

T: +44 (0)1827 300640

E: sales@oviaUK.com | W: oviaUK.com