

INCEPTOR® IONA

Technical Specification



Product Code: OV65308CTASDGL

Description: 30W 230mm Diameter Switch Dimmable Downlight With Drop Glass CTA Switch - IP44 - White

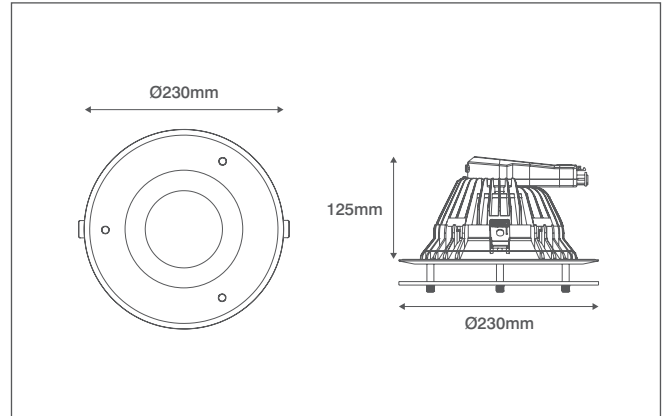

General Information

Dimensions	230mm Diameter x 125mm (D)
Materials	Bezel & Heatsink: Powdercoated Aluminium Diffuser: Polycarbonate Engine Housing: Polycarbonate
Finish	White (RAL 9003)
Product Weight	1.3Kg
Cutout	190mm Diameter
Dimmable	Yes (Switch Dim)
Ingress Protection	IP44
Warranty	5 Years

Supply & Power

Input Voltage & Frequency	220-240V~ 50/60Hz
Electrical Safety	Class II (Double Insulated)
LED Wattage	30W
Circuit Wattage	30W
Input Current	160mA
In-rush Current	4.44A (79.2µs)
Power Factor	>0.9
Ambient Temperature (Ta)	-15°C - +25°C
Critical Temperature	+80°C
LED Driver	Integrated
Prewired Flow™ Connector	Yes (3 Pole CT105-F Push-fit Terminals)
Dimming Input Termination	2 Pole Flow™ Connector (CT001-F)

Luminaire Output

Colour Temperature	2700K	4000K	6500K
Typical Luminous Flux	1900lm	2150lm	2100lm
Efficacy	63lm/W	72lm/W	70lm/W
Beam Angle	75°		
CRI	>80		
LED Lifetime (L70)	50,000 Hours		

Accessories

OVCGEM6500	3 Hour Emergency Pack With prewired Flow™ Connectors
-------------------	--

Additional Information

4.6V DC Switch Dim voltage supplied by the fitting

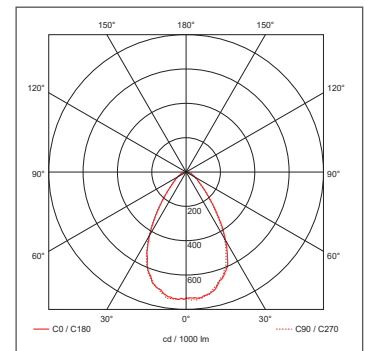
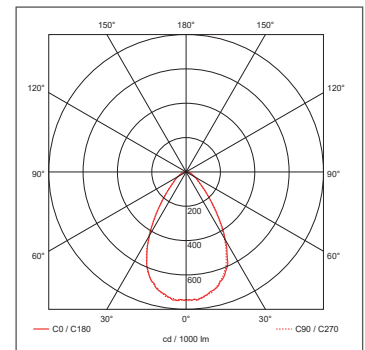
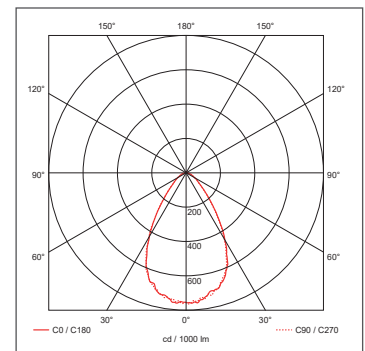

OVIA Limited, Scolmore House, Mariner, Lichfield Road Industrial Estate, Tamworth, Staffordshire, B79 7UL United Kingdom

T: +44 (0)1827 300640

E: sales@oviaUK.com | **W:** oviaUK.com